

ANTARES Infrared LED Floodlight 21 W (24VDC)

odak® R&D CENTER
smart city technologies



General Application Areas

Optical Beam Angles



Imaging Systems



ANPR

General Information

The Antares LED Floodlight is an LED-based lighting device used to support red violation systems. Its energy-efficient red light has been optimized for night vision. The luminaire body is engineered to withstand outdoor conditions. It has an 10° light angle for red violation, license plate reading, and other roadway detection systems. It offers options for 17°, 25°, 40°, 45°, 60°, 90°, and 120°, suitable for various applications.

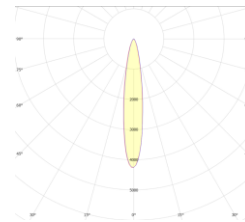

10°

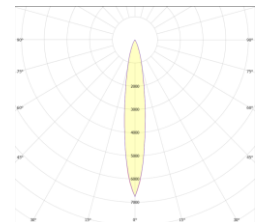

17°

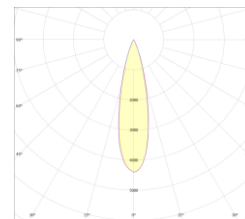

25°

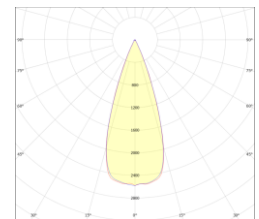

40°

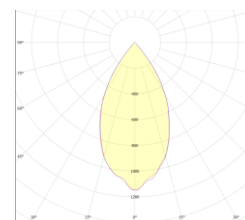

45°

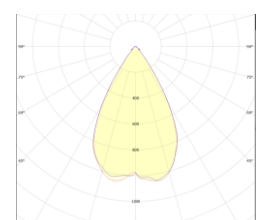

60°

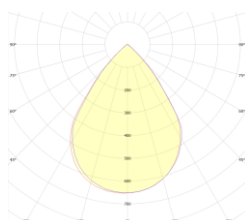

90°

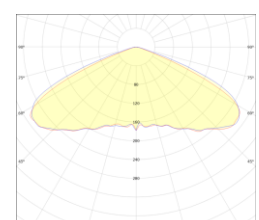

112°

ANTARES Infrared LED Floodlight 21 W (24VDC)

odak®
R&D
CENTER
smart city technologies

Technical Specifications

Body	: Aluminum Injection
Color Options	: RAL 9004
IP Protection Class	: IP 66
Front Cover	: Tempered Glass
Light source	: LED
Lens	: PMMA
Test Standards	: TS EN 60598-1, TS EN 60598-2-5, TS EN 62031, TS EN 62262, TS IEC TR 62471, TS EN 62722-2-1

Optical and Electrical Properties

Power	21W	Total Harmonic Distortion	<%20
Wavelength	850nm	Power Factor	>0,95
Throttling Options:	1-10V, TRIAC, DALI	Infrared Emission	10 W
Light Angle	10°, 17°, 25°, 40°, 45°, °60°, 90°, 120°	Weight	1.5 kg
Input Voltage	24VDC	Dimensions	228,3x228x51,8 mm

Other Features

Operating Temperature	-25°/+55°C	CE Marking	Yes
Impact Resistance Class	IK 08	RoHS Compliance	Yes
Lifetime	≥30,000 Hours	Warranty Period	3 Years

Properties

- Ideal for Traffic Application.
- Extra long life with very low maintenance.
- IP66 Enclosure for Outdoor Mounting.
- Compact with integrated LED Light Source.
- The pulse range can be adjusted from 1.6K~30KHz.
- Standalone or External trigger
- Synchronized support with camcorde (NTSC&PAL)
- Super long range up to 50m.

ANTARES Infrared LED Floodlight 21 W (24VDC)

Technical Drawing (Side View) and Wiring Diagram

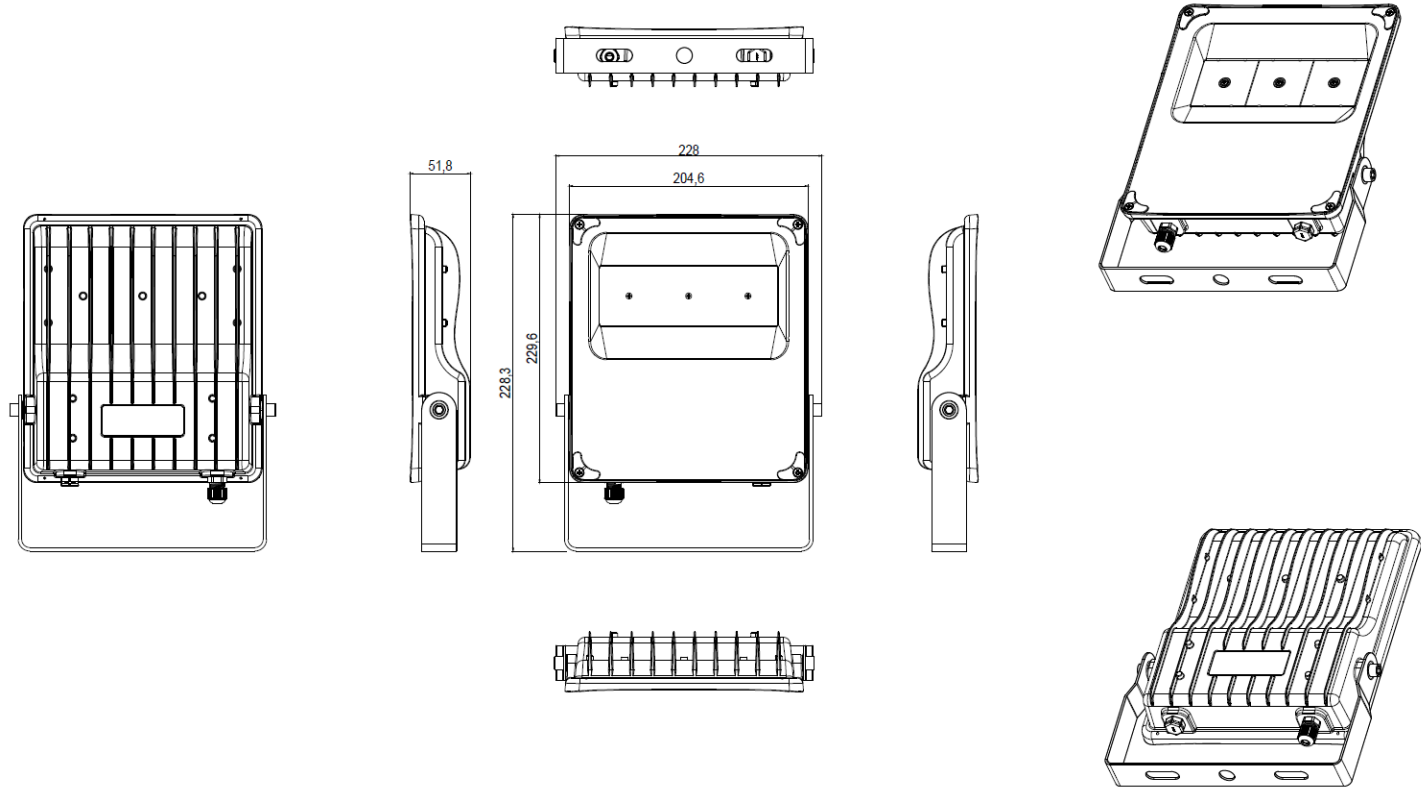

Product Variations

Product Code	Power	Input Voltage	Infrared Emission	Wavelength	Light Angle	Dimensions	Weight
ANT-021SM-00102-850-9004	21 W	24 VDC	10 W	850 nm	10°	228,3x228x51,8 mm	1.5kg
ANT-021SM-00172-850-9004	21 W	24 VDC	10 W	850 nm	17°	228,3x228x51,8 mm	1.5kg
ANT-021SM-00252-850-9004	21 W	24 VDC	10 W	850 nm	25°	228,3x228x51,8 mm	1.5kg
ANT-021SM-00402-850-9004	21 W	24 VDC	10 W	850 nm	40°	228,3x228x51,8 mm	1.5kg
ANT-021SM-00452-850-9004	21 W	24 VDC	10 W	850 nm	45°	228,3x228x51,8 mm	1.5kg
ANT-021SM-00602-850-9004	21 W	24 VDC	10 W	850 nm	60°	228,3x228x51,8 mm	1.5kg
ANT-021SM-00902-850-9004	21 W	24 VDC	10 W	850 nm	90°	228,3x228x51,8 mm	1.5kg
ANT-021SM-01202-850-9004	21 W	24 VDC	10 W	850 nm	120°	228,3x228x51,8 mm	1.5kg